

SMIK1-B - GVI1

MELDINGEN

X200 ENKELMELDINGEN

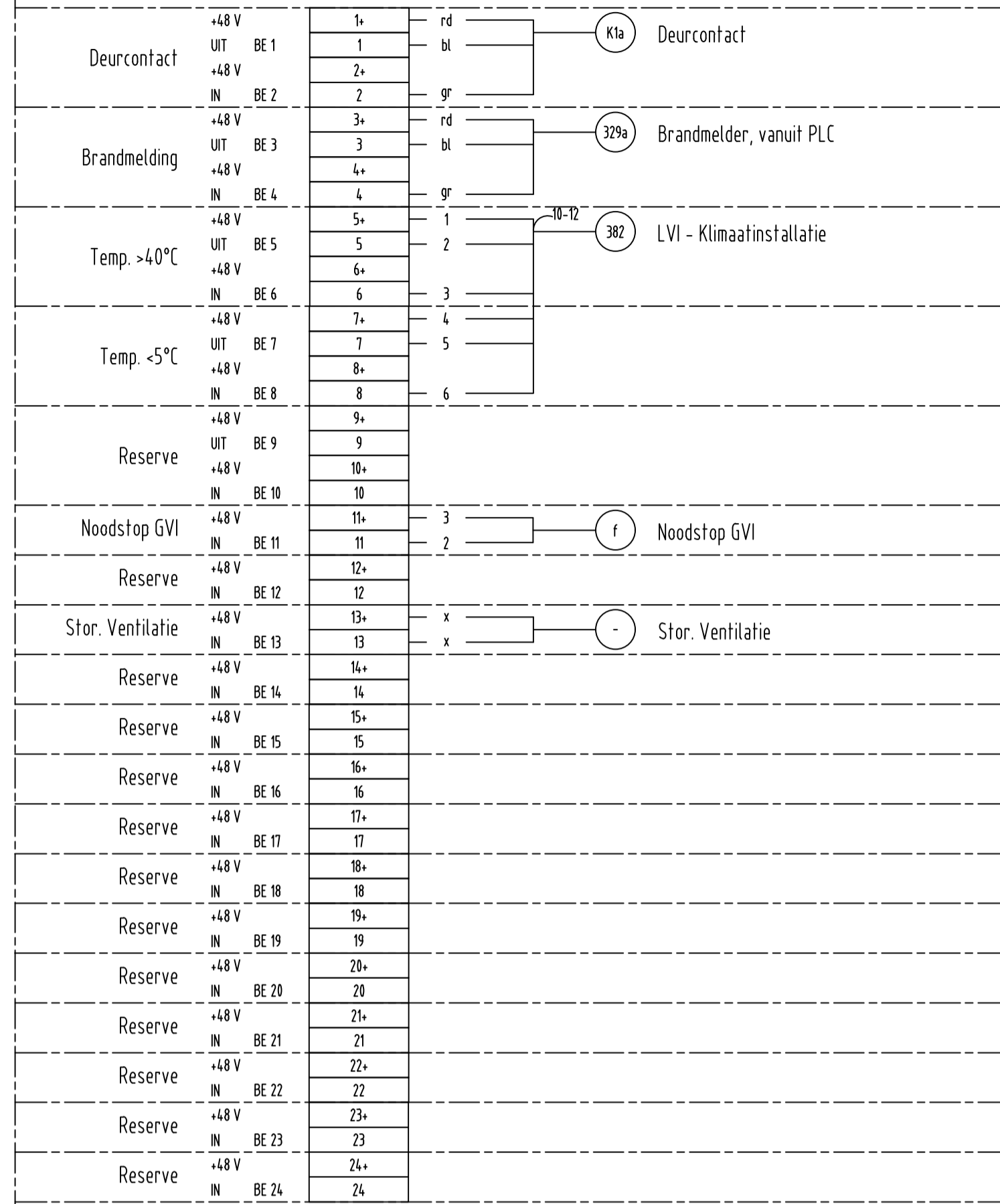

X300 ANALOGIE METINGEN

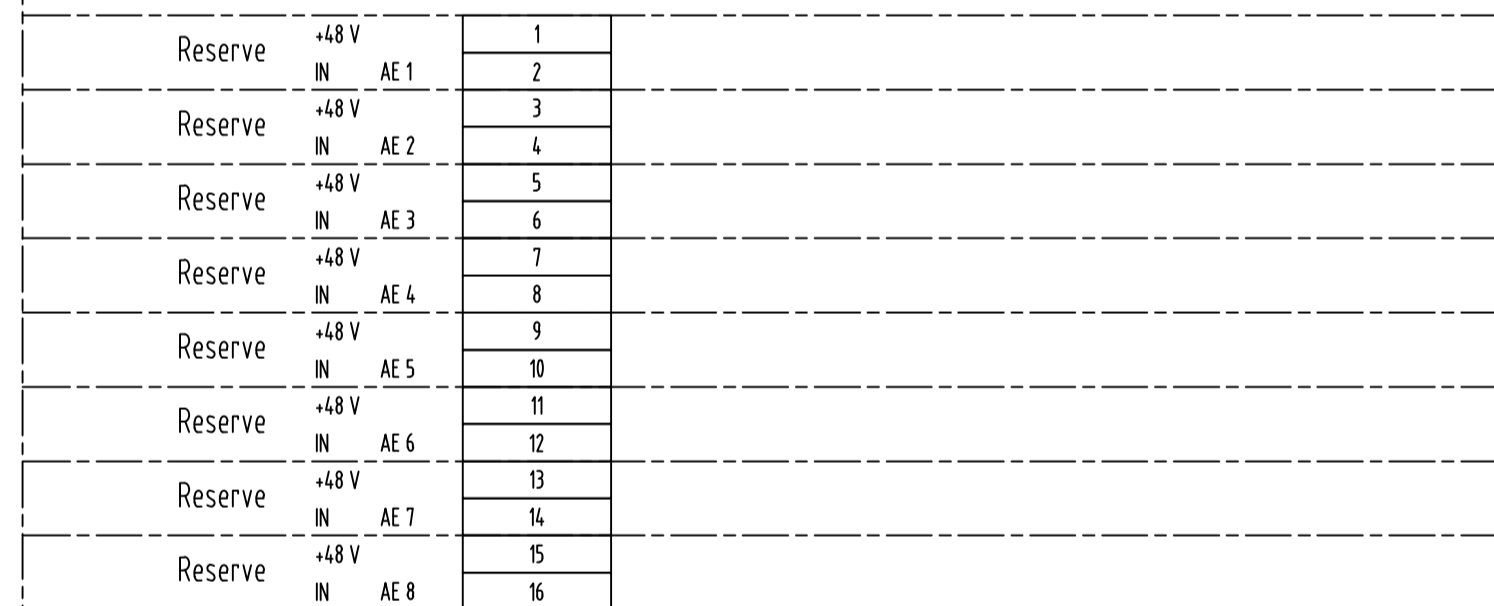

OVERIGE

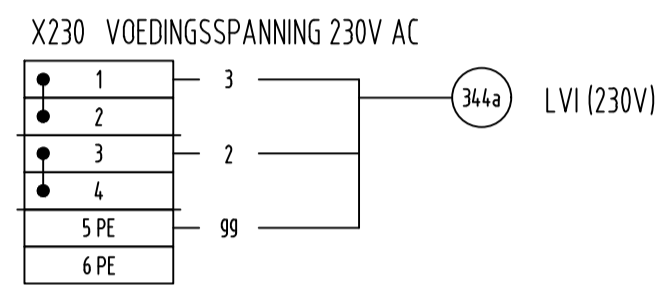
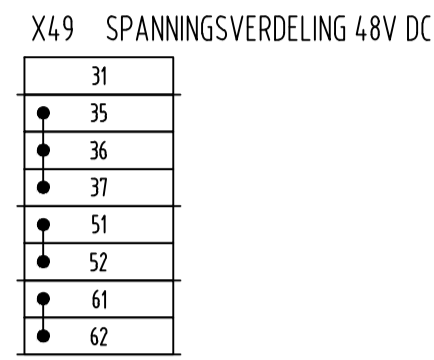
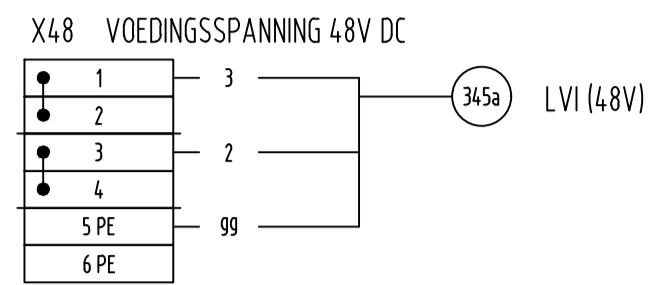

X300 ANALOGIE SIGNALLEN

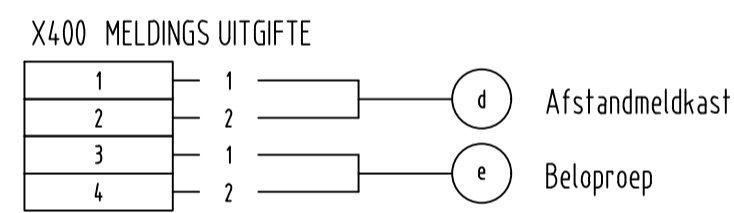
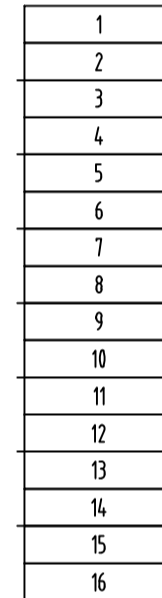

A100.A PROCES MODULE

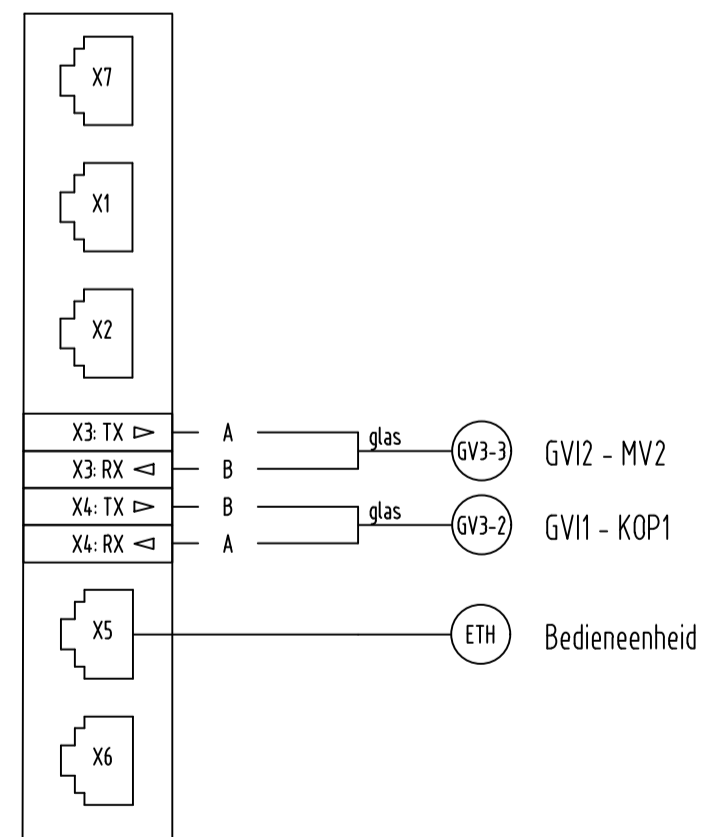

Opmerking	
Adercodering	
Aderkleur	Adernummer
Zwart	1
Blauw	2
Bruin	3
Zwart/Wit of Grijs	4

Transformatie aderkleur naar adernummer voor kabel LIYCY 10 - nx0,75 mm ²	
Aderkleur	Adernummer
Rood	1
Blauw	2
Geel	3
Groen	4
Wit	5
Zwart	6
Bruin	7
Grijs	8
Rose	9
Paars	10
Wit-Rood	11
Bruin-Rood	12
Wit-Blauw	13
Bruin-Blauw	14
Wit-Geel	15
Geel-Bruin	16
Wit-Grijs	17
Grijs-Bruin	18
Wit-Rose	19
Rose-Bruin	20
Grijs-Rood	21
Rood-Blauw	22
Wit-Groen	23
Bruin-Groen	24

c 30-03-2026
001 X-003000
Opdrachtnemer
Generiek ontwerp

Deze tekening vervangt:		Formaat	Schaal
000000000	SMIK1	A0	
	Generiek Ontwerp MOS	Geocode	Versie
	OS/SS	000	c
ProRail		To-build	
		1	
		00.000	00.000
		61-28-01 - GVI	