GEMEENTE LELYSTAD

OVL MEET- & VERDEELKAST TYPE: 6RI-3FN-NB LE

BOSMA & BRONKHORST BV

ARIS VAN BROEKWEG 14, 1507 BB, ZAANDAM
E-MAIL: INFO@BOSMA-BRONKHORST.NL

TEL: 075-6531500 FAX: 075-6531501
WWW.BOSMA-BRONKHORST.NL



GET.:	RG	AANM.DAT.:	01-07-2024
GEW.:	RG	WIJZ.DAT.:	
PROJ.NR.:		SCHAAL:	NVT
BOUWJR.:		OPDR.GEV.:	
FORMAAT:	A4	OPDR.REF.:	

REVISIE	A	
	B	
	C	
	D	
	E	

ONDERWERP:
VOORBLAD
OVL MEET- & VERDEELKAST TYPE: 6RI-3FN-NB LE
GEMEENTE LELYSTAD

TEK.NR:
6RI-3FN-NB LE

BLAD: 01 REV:

INHOUDSOPGAVE

TEKENINGNUMMER:	BLADNR.:	PAGINABESCHRIJVING:	REVISIE:	DATUM:	GEWIJZIGD DOOR:
6RI-3FN-NB LE	01	VOORBLAD	-	01-07-2024	RG
	02	INHOUDSOPGAVE	-	01-07-2024	RG
	03	DRAADKLEUREN & CODERING	-	01-07-2024	RG
	04	RESERVE	-	-	-
	10	KASTAANZICHT	-	01-07-2024	RG
	11	KASTAANZICHT	-	01-07-2024	RG
	12	RESERVE	-	-	-
	20	INSTALLATIESHEMA	-	01-07-2024	RG
	21	RESERVE	-	-	-
	25	AARDINGSSHEMA	-	01-07-2024	RG
	26	RESERVE	-	-	-
	30	STROOMKRINGSHEMA	-	01-07-2024	RG
	31	STROOMKRINGSHEMA	-	01-07-2024	RG
	32	RESERVE	-	-	-
	33	RESERVE	-	-	-
	34	RESERVE	-	-	-
	40	KLEMMENSTROOK - X1	-	01-07-2024	RG
	41	RESERVE	-	-	-
	42	KLEMMENSTROOK - X2	-	01-07-2024	RG
	43	RESERVE	-	-	-
	44	RESERVE	-	-	-
	45	RESERVE	-	-	-
	50	COMPONENTENLIJST	-	01-07-2024	RG
51	COMPONENTENLIJST	-	01-07-2024	RG	
52	RESERVE	-	-	-	

BOSMA & BRONKHORST BV

ARIS VAN BROEKWEG 14, 1507 BB, ZAANDAM
E-MAIL: INFO@BOSMA-BRONKHORST.NL

TEL: 075-6531500 FAX: 075-6531501
WWW.BOSMA-BRONKHORST.NL



GET.:	RG	AANM.DAT.:	01-07-2024
GEW.:	RG	WIJZ.DAT.:	
PROJ.NR.:		SCHAAL:	NVT
BOUWJR.:		OPDR.GEV.:	
FORMAAT:	A4	OPDR.REF.:	

REVISIE	A	
	B	
	C	
	D	
	E	

ONDERWERP:
INHOUDSOPGAVE
OVL MEET- & VERDEELKAST TYPE: 6RI-3FN-NB LE
GEMEENTE LELYSTAD

TEK.NR:
6RI-3FN-NB LE

BLAD: 02 REV:

DRAADKLEUREN

400VAC Hoofdstroom	Fase Nul Aarde	Zwart Licht Blauw Groen/Geel
230VAC Hoofdstroom	Fase Schakeldraad Nul Aarde	Bruin Zwart Licht Blauw Groen/Geel
230VAC Stuurstroom	Fase Schakeldraad Nul	Bruin Zwart Licht Blauw
24VAC/48VAC	Fase Nul Schakeldraad	Oranje Oranje Oranje-Wit (Gestreept)
24VDC	+ -	Rood-Wit (Gestreept) Blauw-Wit (Gestreept)
DALI+ DALI-	+ -	Rood Zwart
Meetdraden Stroomtrafo		Zwart
Meet- & Regel (0-5/10V, 0/4-20mA)		Wit
Potentiaalvrij		Transparant
Intrinsiek Veilig		Donker Blauw
Overig		Paars

KLEMMENSTROOK CODERING

X1 : Hoofdstroom
X2 : Stuurstroom

COMPONENT CODERING

C : Meetspoel
D : Diagnose / Testaansluiting
E : Verwarming
F : Installatieautomaat / Aardlekautomaat / Overspanningsbeveiliging
GR : Met zekeringen afgezekerde groep
GS : Groepschakelaar
H : Verlichting
HS : Hoofdschakelaar
K : Installatierelais / Magneetrelais / Hulprelais / Begrenzers
kWh : Kilowattuurmeter
MU : Meettransformator
PS : Voeding
Q : Magneetschakelaar / Contactor
RC : Filter / Snubberrelais
S : Schakelaar / Drukknop
T : Tijdrelais / Schakelklok
TH : Thermostaat / Hygrostaat
U : Overige componenten
V : Verdeelblok
W : Antenne
X : Klemmenstrook / Wandcontactdoos

BOSMA & BRONKHORST BV

ARIS VAN BROEKWEG 14, 1507 BB, ZAANDAM
E-MAIL: INFO@BOSMA-BRONKHORST.NL

TEL: 075-6531500 FAX: 075-6531501
WWW.BOSMA-BRONKHORST.NL



GET.: RG AANM.DAT.: 01-07-2024
GEW.: RG WIJZ.DAT.:
PROJ.NR.: SCHAAL: NVT
BOUWJR.: OPDR.GEV.:
FORMAAT: A4 OPDR.REF.:

REVISIE
A
B
C
D
E

ONDERWERP:
DRAADKLEUREN & CODERING
OVL MEET- & VERDEELKAST TYPE: 6RI-3FN-NB LE
GEMEENTE LELYSTAD

TEK.NR:
6RI-3FN-NB LE
BLAD: 03 REV:

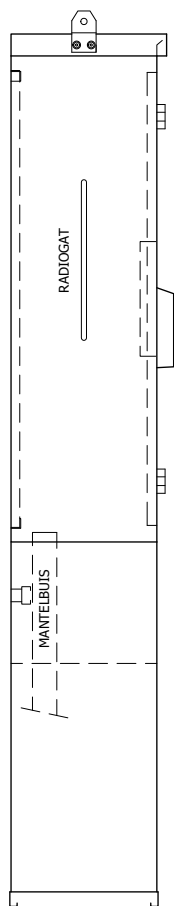

ZIJAANZICHT LINKS

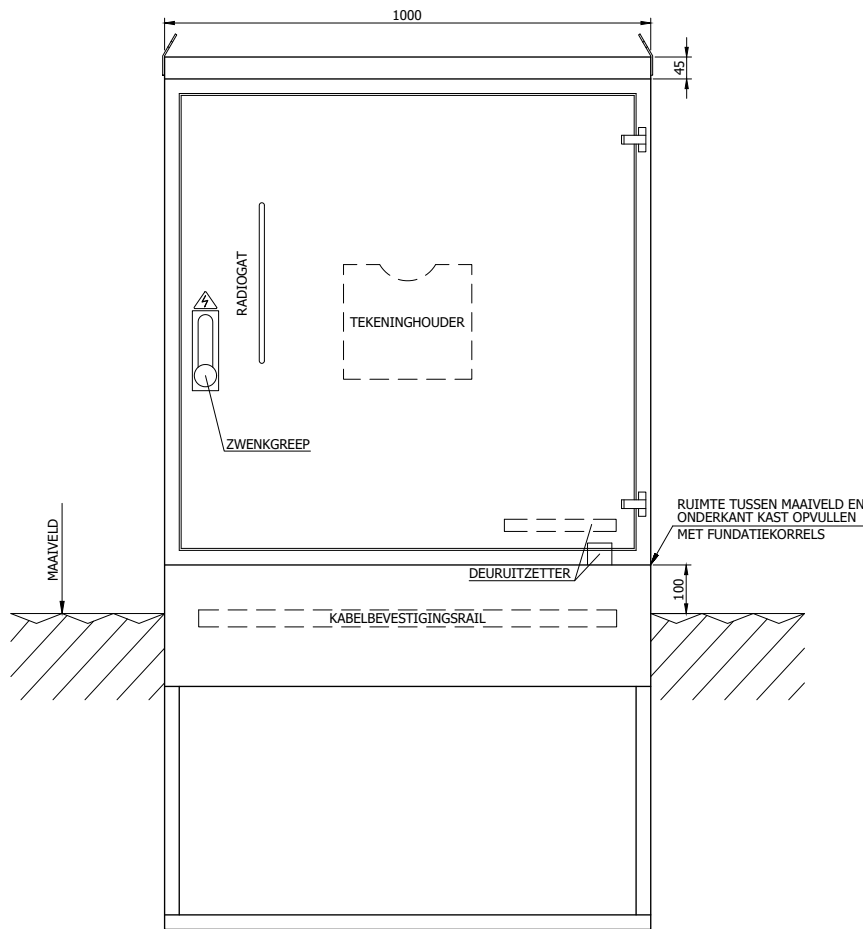

VOORAANZICHT

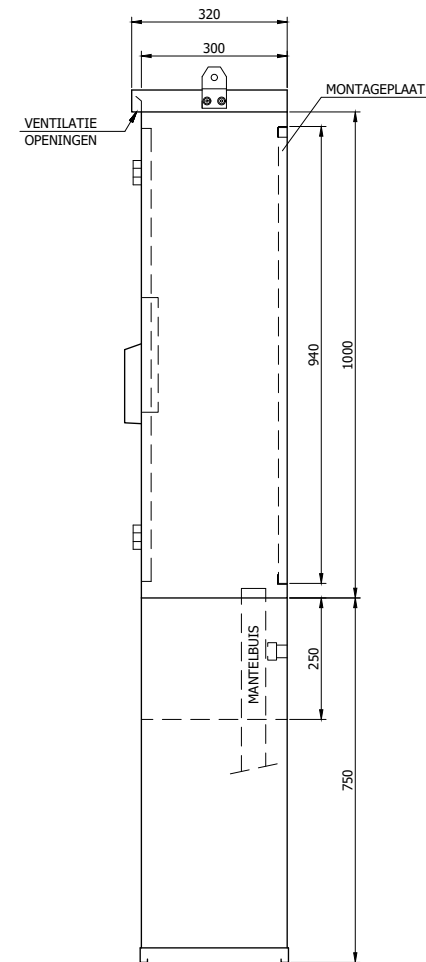

ZIJAANZICHT RECHTS

- ALLE MATEN IN MILLIMETER
- DEMONTABELE INGRAAFSOKKEL
- DEMONTABEL (NAAR 4-ZIJDEN) AFWATEREND DAK
- ALLE METALEN KASTDELEN GEAARD
- DEMONTABELE HIJSGOEN (VERWIJDEREN NA PLAATSING)
- KABELBEVESTIGINGSRAIL IN INGRAAFSOKKEL
- BETONPLEX MONTAGEPLAAT 940x920x18 mm (HxBxD)
- OPLIGGENDE DEURSCHARNIEREN RVS 316L
- STANDAARD HEVELSTANGENSLOT (3-PUNTSVERGRENDLING)

- DEURITHOUDER TOT 105 GRADEN, VERGRENDELD IN GEHEEL GEOPENDE STAND
- INBRAAKWERENDE ZWENKGREEP, ZAMAK, ZWART GEPOEDERCOAT, GESCHIKT VOOR TWEE EUROPROFIEL-HALFCILINDERS, EXCLUSIEF LEVERING CILINDERS
- STICKER MET LOGO GEVAARLIJKE SPANNING BOVEN ZWENKGREEP
- KUNSTSTOF RADIOGAT VOORZIJDE EN LINKERZIJDE KAST
- KUNSTSTOF A4 TEKENINGHOUDER GEMONTEERD OP STIFTEN
- BOSMA & BRONKHORST BV IDENTIFICATIEPLAAT IN DE KAST
- INCLUSIEF LEVERING 1,5 m RODE SLAGVASTE FLEXIBELE MANTELBUIS Ø50 mm
- MONTAGEVOORZIENING VOOR KASTVERLICHTING EN DEURSCHAKELAAR

MATERIAAL	RVS 304L
PLAATDIKTE	2 mm
KLEUR (POEDERCOAT)	RAL 7037
AFWERKING	GEEN
OPTIES	GEEN
GEWICHT KAST LEDIG/TOTAAL	... kg / ... kg
GEWICHT SOKKEL	... kg

BOSMA & BRONKHORST BV

ARIS VAN BROEKWEG 14, 1507 BB, ZAANDAM
E-MAIL: INFO@BOSMA-BRONKHORST.NL

TEL: 075-6531500 FAX: 075-6531501
WWW.BOSMA-BRONKHORST.NL



GET.:	RG	AANM.DAT.:	01-07-2024
GEW.:	RG	WIJZ.DAT.:	
PROJ.NR.:		SCHAAL:	NVT
BOUWJR.:		OPDR.GEV.:	
FORMAAT:	A4	OPDR.REF.:	

REVISIE	A
	B
	C
	D
	E

ONDERWERP:
KASTAANZICHT
OVL MEET- & VERDEELKAST TYPE: 6RI-3FN-NB LE
GEMEENTE LELYSTAD

TEK.NR:
6RI-3FN-NB LE

BLAD: 10 REV:

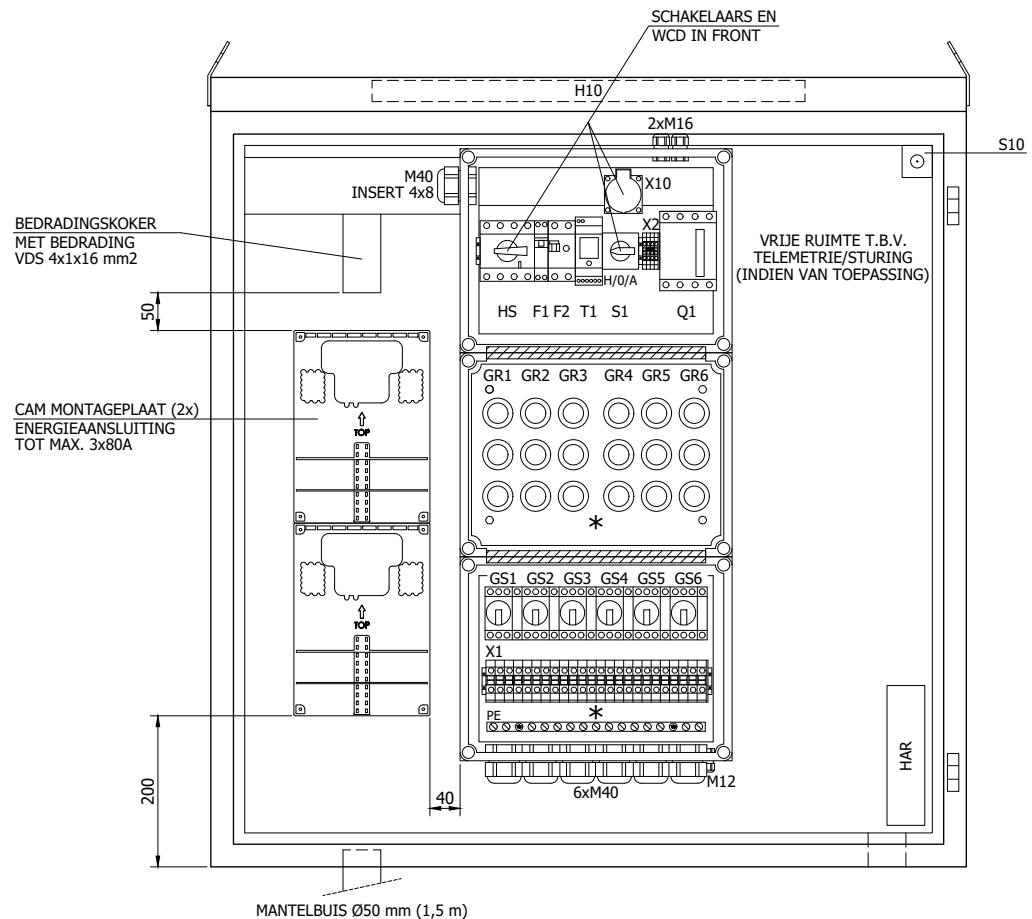

**VOORAANZICHT
(ZONDER DEUR EN SOKKEL)**

- ELEKTRISCHE VEILIGHEIDSKLASSE LAAGSPANNINGSVERDEELKAST : KLASSE I
- TEKSTPLATEN, INDIEN NIET ANDERS AANGEGEVEN, WITTE ACHTERGROND MET ZWARTE LETTERS
- TEKSTPLATEN ZIJN STANDAARD GEPLAKT
- HALYESTER KAST(EN) * - GEMARKEERD ZIJN UITGEVOERD MET HANDBEDIENBARE SLUITINGSSCHROEVEN

BOSMA & BRONKHORST BV

ARIS VAN BROEKWEG 14, 1507 BB, ZAANDAM
E-MAIL: INFO@BOSMA-BRONKHORST.NL

TEL: 075-6531500 FAX: 075-6531501
WWW.BOSMA-BRONKHORST.NL



GET.:	RG	AANM.DAT.:	01-07-2024
GEW.:	RG	WIJZ.DAT.:	
PROJ.NR.:		SCHAAL:	NVT
BOUWJR.:		OPDR.GEV.:	
FORMAAT:	A4	OPDR.REF.:	

REVISIE

A
B
C
D
E

ONDERWERP:
KASTAANZICHT
OVL MEET- & VERDEELKAST TYPE: 6RI-3FN-NB LE
GEMEENTE LELYSTAD

TEK.NR:
6RI-3FN-NB LE

BLAD: 11 REV:

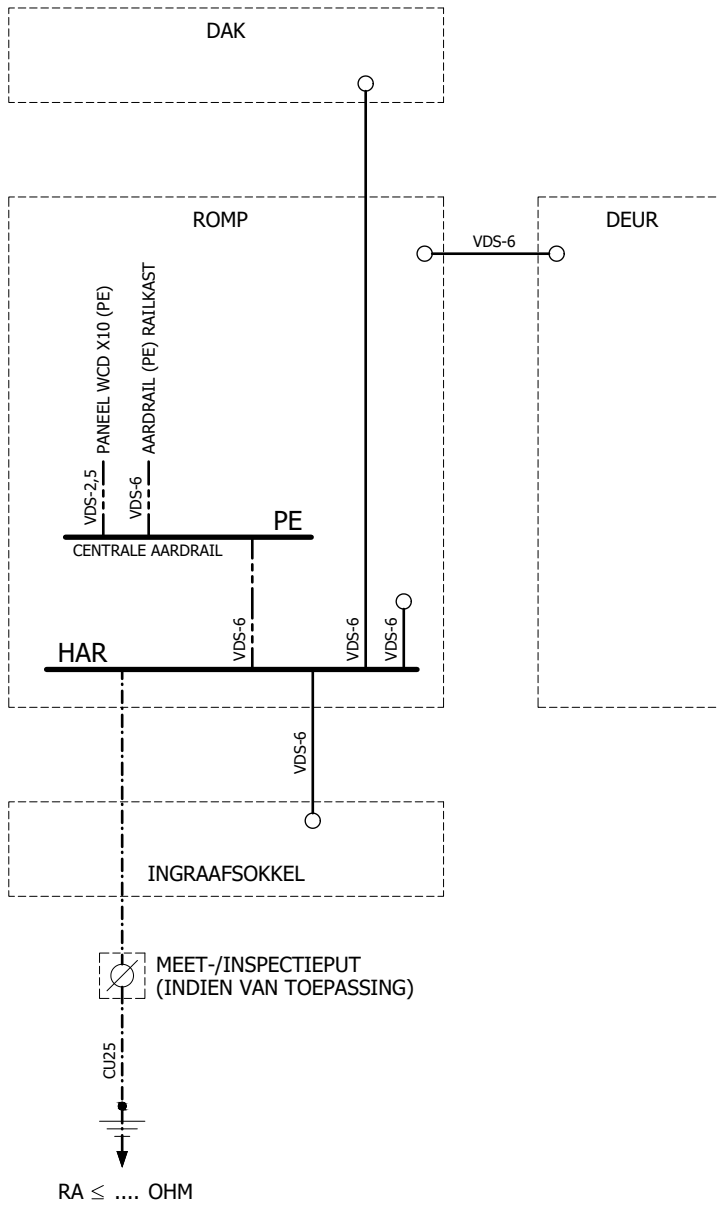

LEGENDA

- HAR = HOOFDAARDRAIL
- AR = AARDRAIL
- PE = AARDRAIL VERDEELKAST
- CU25 = KOPER KERNDORSNEDE 25 mm²
- VDS-X = VDS DRAAD X = .. mm²
- = AARDLEIDING
- = BESCHERMLEIDING
- = VEREFFENINGSLEIDING

BOSMA & BRONKHORST BV

ARIS VAN BROEKWEG 14, 1507 BB, ZAANDAM
 E-MAIL: INFO@BOSMA-BRONKHORST.NL

TEL: 075-6531500 FAX: 075-6531501
 WWW.BOSMA-BRONKHORST.NL



GET.:	RG	AANM.DAT.:	01-07-2024
GEW.:	RG	WIJZ.DAT.:	
PROJ.NR.:		SCHAAL:	NVT
BOUWJR.:		OPDR.GEV.:	
FORMAAT:	A4	OPDR.REF.:	

REVISIE	A	
	B	
	C	
	D	
	E	

ONDERWERP:
 AARDINGSSCHEMA
 OVL MEET- & VERDEELKAST TYPE: 6RI-3FN-NB LE
 GEMEENTE LELYSTAD

TEK.NR: 6RI-3FN-NB LE	
BLAD: 25	REV:

1	2	3	4	5	6	7	8	9	10	11	12	13	14	15
INKOMENDE VOEDING					VOEDING	HAND/O/AUTO	MAGNEETSCHAK.	ASTRO		VOEDING WCD +	DEUR-	KASTVERLICHTING	SERVICE WCD	
HOOFDSCHAKELAAR					STUURSTROOM	SCHAKELAAR	INSCHAKELLEN	SCHAKELKLOK		KASTVERLICHTING	SCHAKELAAR	LED 230VAC/8W	230VAC IN FRONT	
HS					F1	S1	Q1	T1		F2	S10	H10	X10	

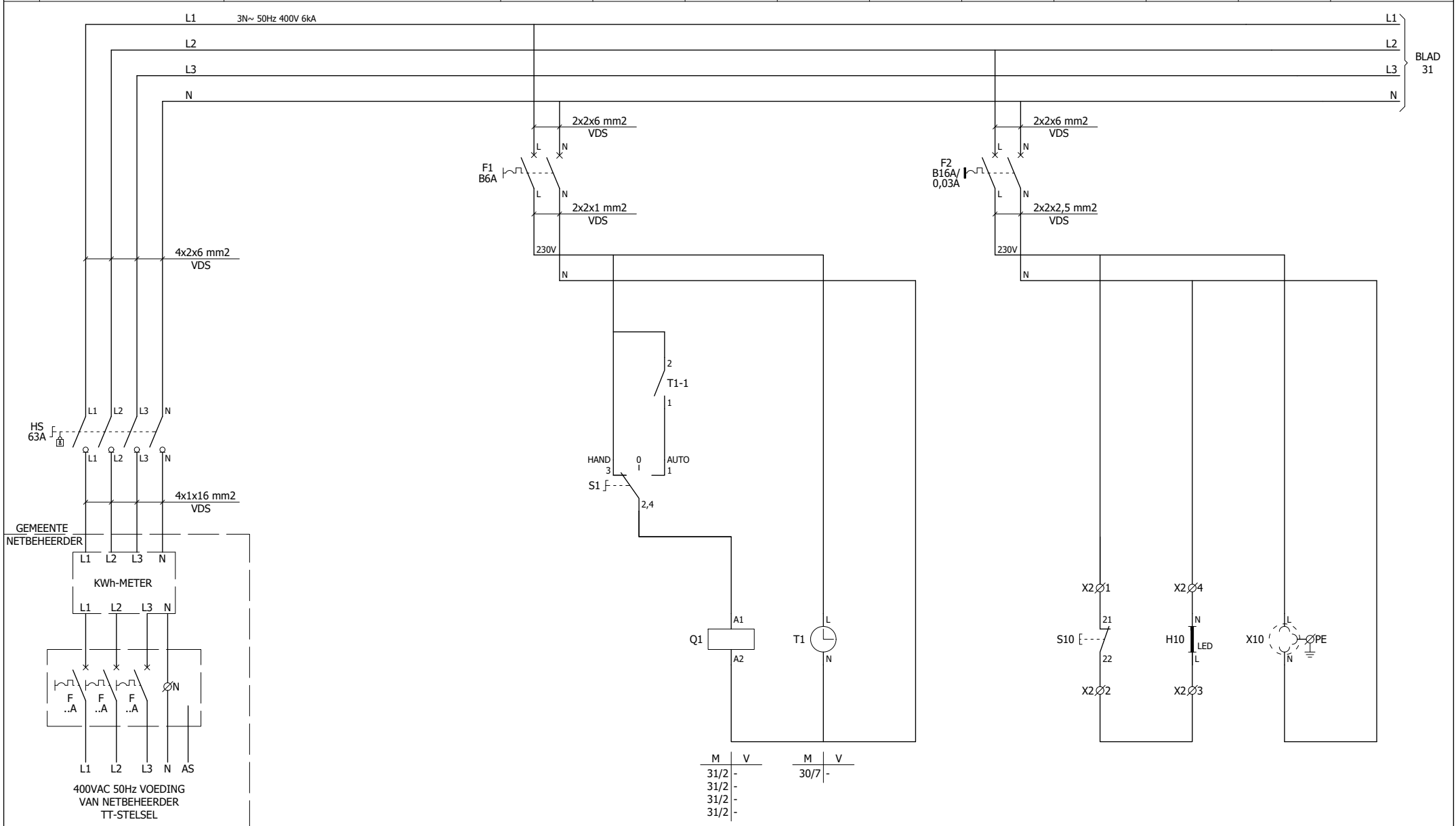

BOSMA & BRONKHORST BV

ARIS VAN BROEKWEG 14, 1507 BB, ZAANDAM
E-MAIL: INFO@BOSMA-BRONKHORST.NL

TEL: 075-6531500 FAX: 075-6531501
WWW.BOSMA-BRONKHORST.NL



GET.: RG AANM.DAT.: 01-07-2024
GEW.: RG WIJZ.DAT.:
PROJ.NR.: SCHAAL: NVT
BOUWJR.: OPDR.GEV.:
FORMAAT: A4 OPDR.REF.:

REVISIE
A
B
C
D
E

ONDERWERP:
STROOMKINGSCHAMA
OVL MEET- & VERDEELKAST TYPE: 6RI-3FN-NB LE
GEMEENTE LELYSTAD

TEK.NR:
6RI-3FN-NB LE

BLAD: 30 REV:

	1	2	3	4	5	6	7	8	9	10	11	12	13	14	15
		MAGNEETSCHAK.		OPENBARE		OPENBARE		OPENBARE		OPENBARE		OPENBARE		OPENBARE	
		INSCHAKELLEN		VERLICHTING		VERLICHTING		VERLICHTING		VERLICHTING		VERLICHTING		VERLICHTING	
		Q1		GROEP 1		GROEP 2		GROEP 3		GROEP 4		GROEP 5		GROEP 6	

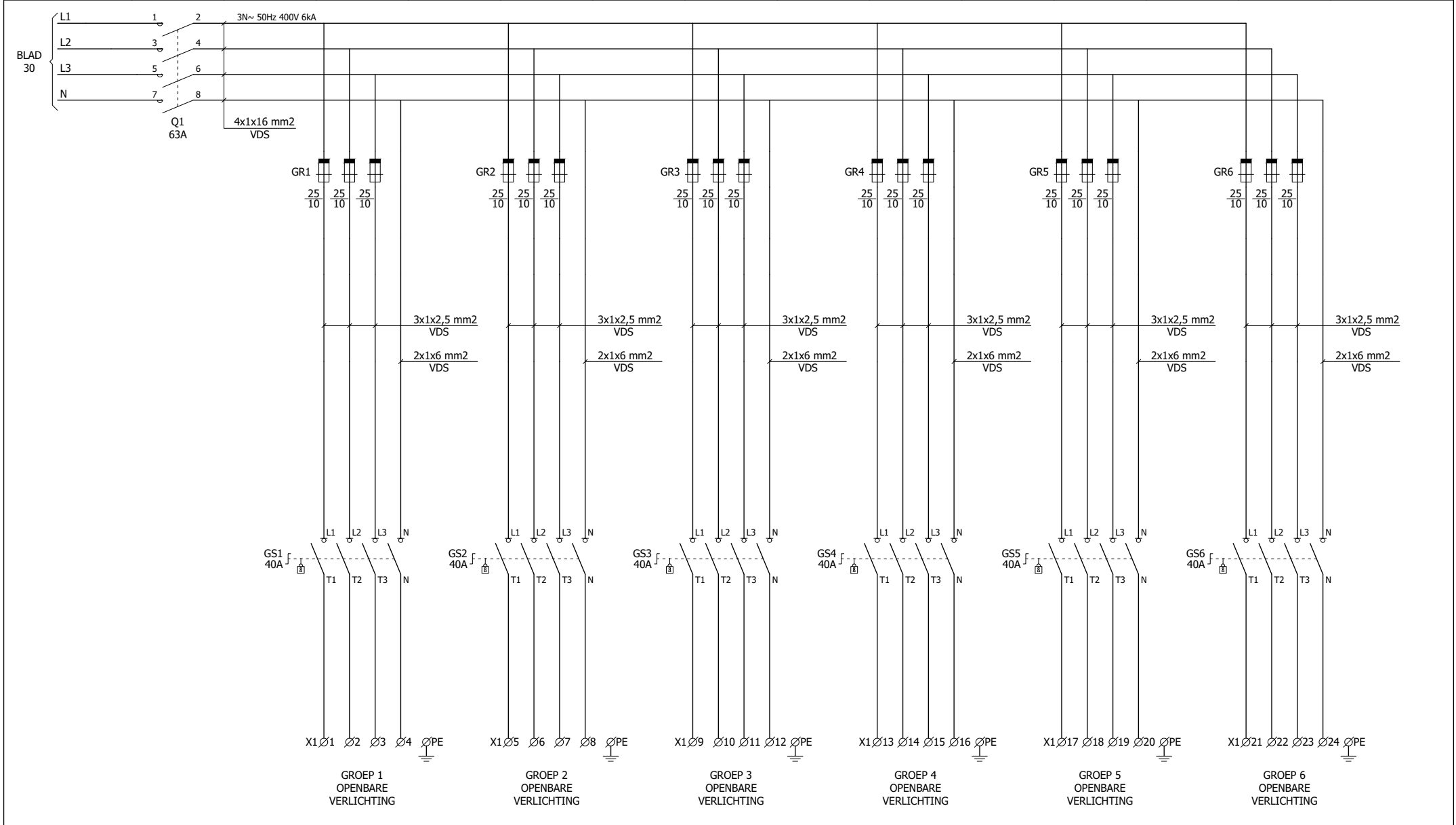

BOSMA & BRONKHORST BV ARIS VAN BROEKWEG 14, 1507 BB, ZAANDAM E-MAIL: INFO@BOSMA-BRONKHORST.NL TEL: 075-6531500 FAX: 075-6531501 WWW.BOSMA-BRONKHORST.NL		GET.: RG	AANM.DAT.: 01-07-2024	A B C D E	ONDERWERP: STROOMKRINGSCHEMA OVL MEET- & VERDEELKAST TYPE: 6RI-3FN-NB LE GEMEENTE LELYSTAD	TEK.NR: 6RI-3FN-NB LE	
		GEW.: RG	WIJZ.DAT.:			BLAD: 31	REV:
		PROJ.NR.:	SCHAAL: NVT				
		BOUWJR.:	OPDR.GEV.:				
		FORMAAT: A4	OPDR.REF.:				

BLADVERWIJZING		31/4	=	=	=	31/6	=	=	=	31/8	=	=	=	31/10	=	=	=	31/12	=	=	=	31/14	=	=	=
HOOFDAARDRAIL (HAR)	VDS 1x6 mm2																								
AARDRAIL (PE) RAILKAST	VDS 1x6 mm2									GG															
WCD X10 (PE)	VDS 1x2,5 mm2					GG																			
GROEPSCHAKELAAR GS6	VD 4x1x6 mm2																					ZW	ZW	ZW	BL
GROEPSCHAKELAAR GS5	VD 4x1x6 mm2																					ZW	ZW	ZW	BL
GROEPSCHAKELAAR GS4	VD 4x1x6 mm2													ZW	ZW	ZW	BL								
GROEPSCHAKELAAR GS3	VD 4x1x6 mm2									ZW	ZW	ZW	BL												
GROEPSCHAKELAAR GS2	VD 4x1x6 mm2						ZW	ZW	ZW	BL															
GROEPSCHAKELAAR GS1	VD 4x1x6 mm2	ZW	ZW	ZW	BL																				

COMPONENT	KABELTYPE																																																					
X1	AANGESLOTEN COMPONENT	G51-T1	G51-T2	G51-T3	G51-N	PE	G52-T1	G52-T2	G52-T3	G52-N	PE	G53-T1	G53-T2	G53-T3	G53-N	G54-T1	G54-T2	G54-T3	G54-N	G55-T1	G55-T2	G55-T3	G55-N	G56-T1	G56-T2	G56-T3	G56-N	PE																										
	KLEMMUMMER	1	2	3	4		5	6	7	8		9	10	11	12	13	14	15	16		17	18	19	20	21	22	23	24																										
	KLEM	○	○	○	○		○	○	○	○		○	○	○	○		○	○	○	○		○	○	○	○	○	○	○	○																									
	AARDDRAIL (PE)					●					●					●									●					●																								
	AANGESLOTEN COMPONENT	OV/L1-L1	OV/L1-L2	OV/L1-L3	OV/L1-N	OV/L1-PE	OV/L2-L1	OV/L2-L2	OV/L2-L3	OV/L2-N	OV/L2-PE	OV/L3-L1	OV/L3-L2	OV/L3-L3	OV/L3-N	OV/L3-PE	OV/L4-L1	OV/L4-L2	OV/L4-L3	OV/L4-N	OV/L4-PE	OV/L5-L1	OV/L5-L2	OV/L5-L3	OV/L5-N	OV/L5-PE	OV/L6-L1	OV/L6-L2	OV/L6-L3	OV/L6-N	OV/L6-PE																							

KABELNUMMER	KABELTYPE																																													
GR1	EO-YMeKasz 4x10 mm2	BR	ZW	GR	BL	AS																																								
GR2	EO-YMeKasz 4x10 mm2						BR	ZW	GR	BL	AS																																			
GR3	EO-YMeKasz 4x10 mm2											BR	ZW	GR	BL	AS																														
GR4	EO-YMeKasz 4x10 mm2															BR	ZW	GR	BL	AS																										
GR5	EO-YMeKasz 4x10 mm2																BR	ZW	GR	BL	AS																									
GR6	EO-YMeKasz 4x10 mm2																	BR	ZW	GR	BL	AS																								

BESTEMMING																													
OPENBARE VERLICHTING GR1	=	=	=	=	=																								
OPENBARE VERLICHTING GR2	=	=	=	=	=																								
OPENBARE VERLICHTING GR3	=	=	=	=	=																								
OPENBARE VERLICHTING GR4	=	=	=	=	=																								
OPENBARE VERLICHTING GR5	=	=	=	=	=																								
OPENBARE VERLICHTING GR6	=	=	=	=	=																								

BOSMA & BRONKHORST BV ARIS VAN BROEKWEG 14, 1507 BB, ZAANDAM E-MAIL: INFO@BOSMA-BRONKHORST.NL TEL: 075-6531500 FAX: 075-6531501 WWW.BOSMA-BRONKHORST.NL		GET.: RG	AANM.DAT.: 01-07-2024	A B C D E	ONDERWERP: KLEMMENSTROOK - X1 OVL MEET- & VERDEELKAST TYPE: 6RI-3FN-NB LE GEMEENTE LELYSTAD	TEK.NR: 6RI-3FN-NB LE
		GEW.: RG	WIJZ.DAT.:			
		PROJ.NR.:	SCHAAL: NVT			
		BOUWJR.:	OPDR.GEV.:			
		FORMAAT: A4	OPDR.REF.:			

AANTAL:	TAG NR.:	OMSCHRIJVING:	TYPE:	FABRIKANT:	ARTIKEL NR.:	COMPART.:
1	-	RVS BUITENKAST 1000x1000x300 mm (HxBxD), RAL 7037	BB.1000.1000.300 NB	BOSMA & BRONKHORST BV	-	-
1	-	RVS INGRAAFSOKKEL 750x1000x300 mm (HxBxD), RAL 7037	BBS.750.1000.300	BOSMA & BRONKHORST BV	-	-
2	-	MONTAGEPLAAT COMPACTE AANSLUITMODULE (CAM)	CT100403	CONNECTENS	CT100403	-
2	-	HALYESTERKAST 270x360x171 mm, TRANSPARANTE DEKSEL, GRONDPLAAT	K434	EATON	1860810	-
1	-	HALYESTER KRACHTGROEPENKAST 6x25A, TRANSPARANTE DEKSEL	GK426a	EATON	1862819	-
4	-	SLUITINGSCHROEF BL78, HANDBEDIENING	Y400H	EATON	1037922	-
2	-	TUSSENSTUK 4, OPEN	U440	EATON	1860723	-
0,4 m	PE	AARDRAIL 63A, MESSING VERNIKKELD, M6x10	12x3 mm	JMV	9200051	-
1	HAR	POTENTIALVEREFFENINGSRAIL GEÏSOLEERD	1809	OBO-BETTERMANN	5015073	-
1	F1	INSTALLATIEAUTOMAAT 1P+N, 6A, B-KARAKTERISTIEK, 6kA	PLN6-B6/1N-MW	EATON	263161	-
1	F2	AARDLEKAUTOMAAT 1P+N, 16A/30mA, B-KARAKTERISTIEK, 6kA	PKN6-16/1N/B/003-A-MW	EATON	236633	-
18	GR1, GR2, GR3, GR4, GR5, GR6	SCHROEFKOP DII, PORSELEIN, VERZEGELBAAR	K II	HAGER	LE27SKP	-
18	GR1, GR2, GR3, GR4, GR5, GR6	D-PASSCHROEF 10A	S II-10	HAGER	LE27P10	-
18	GR1, GR2, GR3, GR4, GR5, GR6	ZEKERING 10A, TRAAG, gG	D II DT II-10A	HAGER	LE2710	-
1	HS	LASTSCHEIDER DUCO 4P, 63A, ZONDER KNOP EN AS	DCM63/4-SK-VC	EATON	1314016	-
1	HS	BEDIENINGSAS	4K6172/188MDCM	EATON	1314281	-
1	HS	DRAAIGREEP DEURINBOUW, 6 mm, BLAUW, HANGSLOTVERGRENDLING	K1DB/P	EATON	1818029	-
2	HS	AFSCHERMKAP	COVERDCM/DMM40/63	EATON	1314331	-
1	Q1	MAGNEETSCHAKELAAR 230V, 4P, 63A	DILMP63 (230V50Hz, 240V60Hz)	EATON	109855	-
8	Q1	KLEMAFDEKKING IP2X VOOR MAGNEETSCHAKELAAR DILMP	DILMP65-XIP2X	EATON	106491	-
6	GS1, GS2, GS3, GS4, GS5, GS6	LASTSCHAKELAAR 3P+N, 40A, VERGRENDLBAAR	KS	ENSTO	KS3.40N	-
1	S1	KEUZESCHAKELAAR HAND-0-AUTO	T0-1-15431/Z	EATON	029364	-
3	S1	ASVERLENGING VOOR KEUZESCHAKELAAR	ZAV-T0	EATON	027044	-
1	T1	SCHAKELKLOK DIGITAAL, ASTRO WEEKPROGRAMMA, 230V, 2-KANAALS	12.A2.8.230.0000	FINDER	EAN 8012823401829	-
1	H10	KASTVERLICHTINGSARMATUUR MET SCHAKELAAR OPBOUW, 230V/8W LED	LN COMP SWITCH 600 8W/4000K	LEDVANCE	EAN 4058075106130	-
1	S10	DEURSCHAKELAAR STOOTNOK, 1M1V, SCHROEFAANSLUITING	LS-S11/F	EATON	106784	-
1	X10	PANEELWANDCONTACTDOOS 230V, 16A, IP54, GRIJS	-	PCE	601.450.03	-

BOSMA & BRONKHORST BV

ARIS VAN BROEKWEG 14, 1507 BB, ZAANDAM
E-MAIL: INFO@BOSMA-BRONKHORST.NL

TEL: 075-6531500 FAX: 075-6531501
WWW.BOSMA-BRONKHORST.NL



GET.:	RG	AANM.DAT.:	01-07-2024
GEW.:	RG	WIJZ.DAT.:	
PROJ.NR.:		SCHAAL:	NVT
BOUWJR.:		OPDR.GEV.:	
FORMAAT:	A4	OPDR.REF.:	

REVISIE

A
B
C
D
E

ONDERWERP:
COMPONENTENLIJST
OVL MEET- & VERDEELKAST TYPE: 6RI-3FN-NB LE
GEMEENTE LELYSTAD

TEK.NR:
6RI-3FN-NB LE

BLAD: 50 REV:

AANTAL:	TAG NR.:	OMSCHRIJVING:	TYPE:	FABRIKANT:	ARTIKEL NR.:	COMPART.:
18	X1	AANSLUITKLEM GRIJS	UT 16	PHOENIX	3044199	-
6	X1	AANSLUITKLEM BLAUW	UT 16 BU	PHOENIX	3044209	-
1	X1	AFSLUITPLAAT	D-UT 16	PHOENIX	3047206	-
4	X2	AANSLUITKLEM GRIJS	UT 2,5	PHOENIX	3044076	-
1	X2	AFSLUITPLAAT	D-UT 2,5/10	PHOENIX	3047028	-
1	X2	STEEKBRUG 2-VOUDIG	FBS 2-5	PHOENIX	3030161	-
4	X1, X2	EINDSTEUN	CLIPFIX 35-5	PHOENIX	3022276	-
7	-	KABELWARTEL KUNSTSTOF IP68	M40	JACOB	50.640 PA7035	-
7	-	KABELWARTEL CONNECTIEMOER	M40	JACOB	50.240 PA7035	-
6	-	KABELWARTEL BLINDDOP	HSK-V PG36/M40 NPT	HUMMEL	1.280.0036.00	-
1	-	KABELWARTEL M40 INZETSTUK 4x8 mm	SKINTOP DIX-M	LAPP	53340480	-
1	-	KABELWARTEL KUNSTSTOF IP68 (VOOR DEURSCHAKELAAR)	M20	JACOB	50.620 PA7035	-
2	-	KABELWARTEL KUNSTSTOF IP68	M16	JACOB	50.616 PA7035	-
2	-	KABELWARTEL CONNECTIEMOER	M16	JACOB	50.216 PA7035	-
1	-	KABELWARTEL KUNSTSTOF IP68	M12	JACOB	50.612 PA7035	-
1	-	KABELWARTEL CONNECTIEMOER	M12	JACOB	50.212 PA7035	-
1,5 m	-	PE KABELBUIS ROOD, D=50 mm (LOS MEEGELEVERD)	MANTELFLEX	WAVIN	7132305050	-

BOSMA & BRONKHORST BV

ARIS VAN BROEKWEG 14, 1507 BB, ZAANDAM
E-MAIL: INFO@BOSMA-BRONKHORST.NL

TEL: 075-6531500 FAX: 075-6531501
WWW.BOSMA-BRONKHORST.NL



GET.: RG AANM.DAT.: 01-07-2024
GEW.: RG WIJZ.DAT.:
PROJ.NR.: SCHAAL: NVT
BOUWJR.: OPDR.GEV.:
FORMAAT: A4 OPDR.REF.:

REVISIE
A
B
C
D
E

ONDERWERP:
COMPONENTENLIJST
OVL MEET- & VERDEELKAST TYPE: 6RI-3FN-NB LE
GEMEENTE LELYSTAD

TEK.NR:
6RI-3FN-NB LE

BLAD: 51 REV: